

de en



Betriebsanleitung

Werkstattwagen VIGOR 1000 XXL Edelstahl- Ausführung, extrabreit

Operating Instructions

Tool Trolley VIGOR 1000 XXL stainless model, extra wide

V4481-XXL

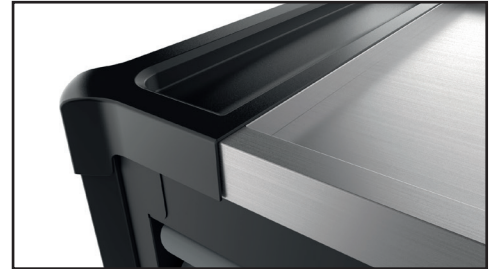

V4481-XXL BA



www.vigor-equipment.com

VIGOR GmbH | Am Langen Siepen 13-15 | 42857 Remscheid | GERMANY



Technische Daten / Technical data:



V4481-XXL

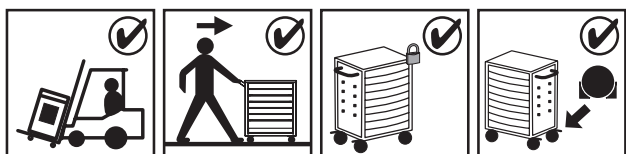
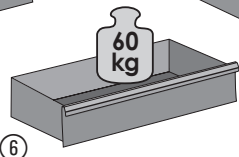
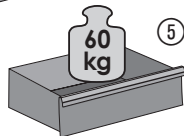
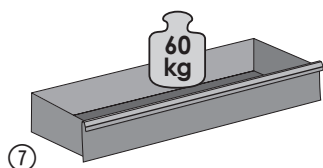
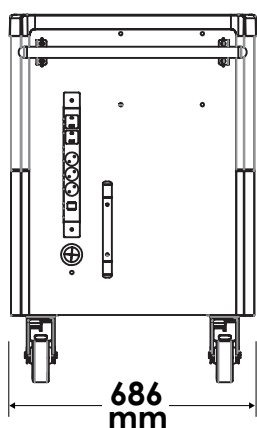
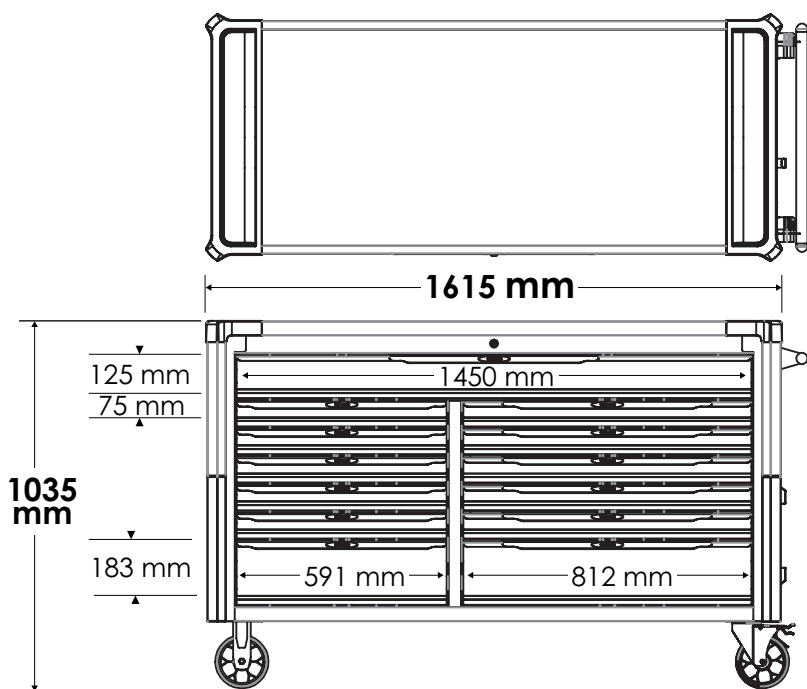

	VIGOR No.	Einzel- und Ersatzteile	Spare Parts
①	V4481-XXL-1	Lenkrolle (Paar)	Swivel Castor (Pair)
②	V4481-XXL-2	Bockrolle (Paar)	Fixed Castor (Pair)
③	V4481-XXL-3	Schublade flach 569 x 570 x 75 mm	Flat Drawer 569 x 570 x 75 mm
④	V4481-XXL-4	Schublade flach 790 x 570 x 75 mm	Flat Drawer 790 x 570 x 75 mm
⑤	V4481-XXL-5	Schublade hoch 569 x 570 x 183 mm	High Drawer 569 x 570 x 183 mm
⑥	V4481-XXL-6	Schublade hoch 790 x 570 x 183 mm	High Drawer 790 x 570 x 183 mm
⑦	V4481-XXL-7	Schublade extra-groß 1450 x 570 x 125 mm	Drawer extra big 1450 x 570 x 125 mm
⑧	V6000-PWR	Steckdosenleiste 3x 230 V, 2x USB, 2x USB Typ C für VSS und V4481-XXL	Power distribution unit 3x 230 V, 2x USB, 2x USB Typ C for VSS and V4481-XXL
⑨	V4481-XXL-8	Kabelhalter für Series XXL	Cable holder for Series XXL
⑩	V4481-XD-5	Fahrgriff	Drive handle

VIGOR No.	Zubehör	Accessories
V2393	Dosenhalter	Can Holder
V2393-S	Dosenhalter, kurz	Can Holder, short
V2393-XD	Dosenhalter, extratief	Can Holder, extra deep
V6221	Laptop-Ablage	Laptop table

VIGOR GmbH • Am Langen Siepen 13-15 • 42857 Remscheid • GERMANY

+49 (0) 21 91 / 97 95 • FAX +49 (0) 21 91 / 97 96 00 • e-mail info@vigor-equipment.com • www.vigor-equipment.com